

Dunlop BTL Ltd

European Distribution Centre
MPT House
Brunswick Road
Cobbs Wood Industrial Estate
Ashford, Kent. UK
TN23 1EL

Contact us

-  +44 (0)1233 663340
-  +44 (0)1233 664440
-  sales@dunlopbt.com
-  www.dunlopbt.com

Manufacturing Facilities

UNITED KINGDOM

FRANCE

GERMANY

ITALY

SPAIN

POLAND

CZECH REPUBLIC

SLOVAKIA

SERBIA

CHINA

USA



CHAIN & PULLEY TENSIONERS

Engineering Data	243
Tensioner Arms	247
Idler Sprocket Sets	248
Idler Roller Pulley Sets	249



TENSIONING TECHNOLOGY

Chain & V-Belt Tensioning

Roller chains are power transmission components with positive transmission which, by virtue of their design are subject, depending on quality, to elongation as a result of wear of 1 to 3% of their total length. In spite of this elongation, due to aging, a roller chain transmits the occurring torques effectively providing it is periodically retensioned. Without tension adjustment, the slack side of the chain becomes steadily longer, oscillates and reduces the force transmitting wrap angle of the chain on the sprockets.

The chain no longer runs smoothly off the teeth of the sprockets, producing uneven running of the entire drive and supporting wear. The service life of the chain drive can be extended considerably by the use of an automatic chain tension adjuster. The tensioning element prevents the slack side of the chain from 'sagging' or 'slapping' by its automatic operation and very wide tensioning range for compensating this given elongation.

The DUNLOP tensioning element is based on the rubber spring principle. According to application it is supplemented with the appropriate idler sprocket for chain drives or with a belt roller pulley in belt tensioner applications.

Pretensioning

With the tensioning element the necessary travel and simultaneously the corresponding initial tension force can be accurately adjusted by a torsion angle scale and indicating arrow. Excessive initial pretensioning of the chain should be avoided in order to reduce the tensile force and surface pressure on the links.

Vibration Damping

The DUNLOP tensioning element, based on a system of rubber springs, absorbs considerably the chain vibration due to internal molecular friction in the rubber inserts. The rubber spring effectively absorbs the vibrations, resulting from the polygon effect, which also positively influences the noise level of the complete chain drive.

INSTALLATION

The idler sprocket is installed in arm position 'normal' or 'hard' in the required position and secured with the supplied nuts.

The laterally adjustable bearing on the thread permits simple and rapid adjustment of the idler sprocket to the chain track. The central fixing of the tensioning element with a single screw saves a great deal of time in installation. In addition, only one fixing hole is required on the 'machine side'.

On smooth, clean and torsionally rigid surfaces the resistance of the frictional contact between the tensioner housing and the machine element is a multiple of the maximum initial tensioning torque at 30°.

TENSIONER TYPE SE

The tensioning element with the specification SE (SE 11 to SE 45) is the mostly used standard unit for tensioning all kinds of chain and belt drives. This unit is designed for applications in temperature range from -40°C to $+80^{\circ}\text{C}$.

Dunlop Idler Sprocket Set Type N

The DUNLOP idler sprocket set completes the tensioning element for applications in chain drives. The idler sprocket runs on a self-lubricating ball bearing Type 2 Z.

Dunlop Idler Roller Pulley Set Type R

The DUNLOP idler roller pulley set installed on the relevant SE unit is an ideal belt tensioner. The roller is made of high quality industrial plastic material with two self lubricating ball bearings Type 2 Z.

GENERAL INFORMATION

DUNLOP tensioners should be installed on a stiff, even and clean machine part means of the central bolt. The frictional connection on flange is usually fully sufficient for final positioning. The positioning notch on flange can be used to assure the tensioner additionally on uneven and dirty surfaces by setting a roller pin.

Tensioning Force F

The tensioning force can be continuously adjusted. The max. pre tensioning angle is $+30^{\circ}$ out of neutral position. Tensioning force table for types SE by using hole-position 'normal' for idler sprocket & idler roller pulley fixation.

Size SE	Pre-tension $< 10^{\circ}$		Pre-tension $< 20^{\circ}$		Pre-tension $< 30^{\circ}$	
	F (N)	s (mm)	F (N)	s (mm)	F (N)	s (mm)
11	15	14	40	28	80	40
15	25	17	65	34	135	50
18	75	17	180	34	350	50
27	150	22	380	44	800	65
38	290	30	730	60	1500	87
45	500	39	1300	78	2600	112

Tensioning Force F

Table mentioning the tightening moment for the central screw (included in scope of delivery).

Thread Size	Quality 8.8
M6	10 Nm
M8	25 Nm
M10	49 Nm
M12	86 Nm
M16	210 Nm
M20	410 Nm

When fixing the idler sprockets and idler roller pulleys in arm position 'hard', the tensioning force will increase by about 25%.

Mounting Instructions

Normal Positioning

The DUNLOP tensioning elements are always positioned on the slack side of the chain. They should be fitted as close as possible to the big wheel and hide the chain from the outer side. The ideal positioning of the tensioning arm is nearly parallel to the chain drive.

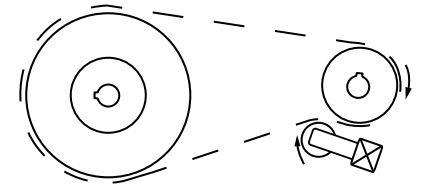

Reversible Chain Drives

The tensioning elements must be placed on both sides of the chain. Due to the reversible function there results a much higher pressure on the load side than on the slack side of the chain. It is therefore advised to use oversized tensioning elements and a pretension angle of max 15°.

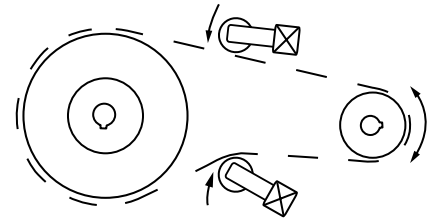

Chain Engagement

At least 3 teeth of the idler sprocket must engage into the roller chain when tensioning the chain for the first time. The minimum number of engaged sprocket teeth between the tensioning wheel and chain is 3.

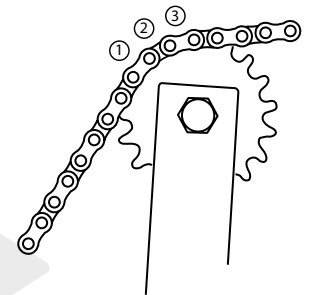

Mounting

The chain tensioner must be adjusted in the axial and angular direction. The tensioning area should be nearly in parallel position to the chain and in the direction of the chain's drive. In case the chain drives are extremely long it is possible to fit several chain tensioners in order to obtain better tensioning and compensation.

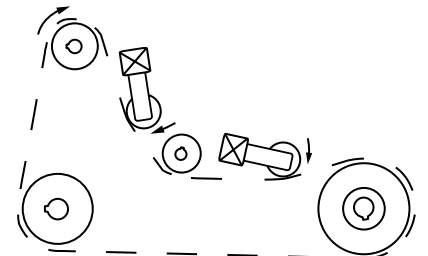

V-Belt Tensioner - Outer Roller

Please refer to the instructions of the belt manufacturer for further information on the belt structure when mounting our DUNLOP belt tensioning elements with flat rollers on the back of the belt. Inner or outer tension rollers must be positioned as far away as possible from the next V-Belt pulley the belt is guided to.

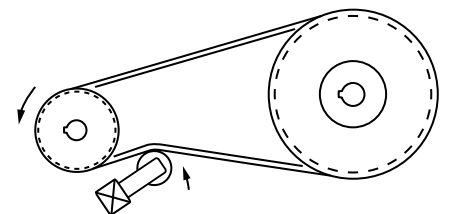

V-Belt Tensioner - Inner Grooved Pulleys

V-Belt pulleys can be mounted as inner rollers at any position on the slack side of the V-Belt (for drives with long axial distances and a high level of vibration we recommend to use pulleys with deep grooves).

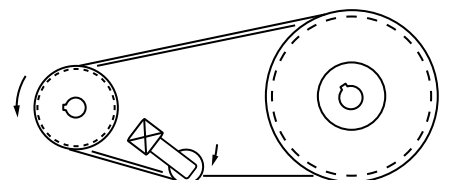

INSTRUCTIONS FOR BELT DRIVES

Selection of the adequate DUNLOP Tensioner size

Selection table mentioning the most conventional V-Belt types.

V-Belt Type	Width (mm)	Height (mm)	Diam. of smaller pulley (mm)	Initial operation test-force F_1^{**} (N)	Initial operation test-force F_0^{**} (N)	Size SE* (without SE-W and SE-B)				
						1 Belt	2 Belt	3 Belt	4 Belt	5 Belt
SPZ, SPZX	10	8	56-71	20	16	11	18	18	18	18
			75-90	22	18	11	18	18	18	27
			95-125	25	20	15	18	18	18	27
			≥ 125	28	22	15	18	18	27	27
SPA, SPAX	13	10	80-100	28	22	15	18	18	27	27
			106-140	38	30	15	18	27	27	27
			150-200	45	36	18	18	27	27	27
			≥ 200	50	40	18	18	27	27	38
SPB, SPBX	16	13	112-160	50	40	18	18	27	27	38
			170-224	62	50	18	27	27	38	38
			236-355	77	62	18	27	38	38	38
			≥ 355	81	65	18	27	38	38	38
SPC, SPCX	22	18	224-250	87	70	18	27	38	38	38
			265-355	115	92	27	38	38	45	45
			≥ 375	144	115	27	38	38	45	45
Z, ZX	10	6	56-100	5-7.5		11	11	11	15	15
A, AX	13	8	80-140	10-15		11	15	18	18	18
B, BX	17	10	125-200	20-30		15	18	18	27	27
C, CX	22	12	200-400	40-60		18	27	27	38	38
D, DX	32	19	355-600	70-105		18	27	38	38	45

*General basic selection criteria:

$$F = F_1 \cdot z \cdot 2$$

- F Resulting tensioning force by a pre-tension angle of 20°.
- F_1 Initial operation test-force according guidelines of the belt manufacturer.
- z Quantity of belts in drive.
- 2 Multiplier for the compensation of belt slippage and/or of centrifugal force generated on belt strands.

**required test-force for belt deflection of 16mm per 1000mm of centre distance. The relevant deflection by shorter or longer centre distance has to be interpolated accordingly.



TENSIONERS

BELT AND CHAIN TENSIONERS

Description

Tensioning devices SE are available for both roller chain and V-Belt applications.

A range of idler sprockets to suit standard roller chain pitch sizes from 06B-1 to 24B-1 are available.

A range of idler roller pulleys are also available to suit standard V and wedge belt sections from Z/SPZ to C/SPC. Both designs have 2Z bearings fitted to the bore.

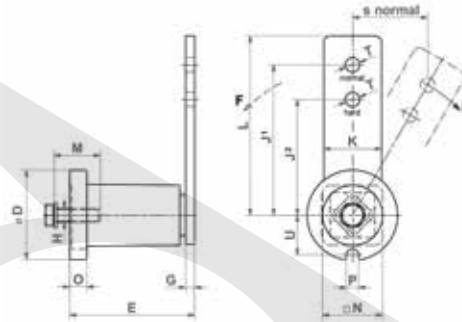

TENSIONER ARM TYPE SE

Part No.	D	E	G	H	J ¹	J ²	K	L	M	N	O	P	T	U	Weight (kg)
SE 11	35	51 +1 -0.5	5	M6	80	60	20	90	20	22	6	8	8.5	16.5	0.2
SE 15	45	64 +1 -0.5	5	M8	100	100	25	112.5	25	30	8	8.5	10.5	20.8	0.4
SE 18	58	79 +1.5 -0.5	7	M10	100	100	30	115	30	35	10.5	8.5	10.5	25.3	0.6
SE 27	78	108 +2 -0.5	8	M12	130	130	50	155	40	52	15	10.5	12.5	34.3	1.7
SE 38	95	140 +2 -0.5	10	M16	175	175	60	205	40	66	15	12.5	20.5	42.0	3.6
SE 45	115	200 +3 -1	12	M20	225	225	70	260	50	80	18	12.5	20.5	52.0	6.4



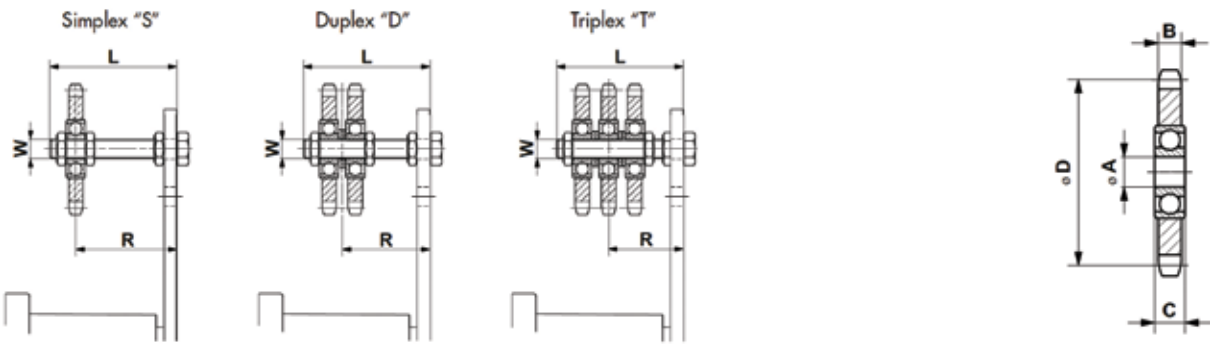

IDLER SPROCKET SETS TYPE N

Rollerchain		Part No.	Number of Teeth	W	L	Torque hex nut 0.5d (Nm)	Adjusting Range Track R	Size SE	Weight (kg)
ANSI	DIN 8187								
Simplex 'S'									
35	ISO 06 B-1	N3/8"-10 S	15	M10	55	20	22-43 / 23-43	15 / 18	0.15
40	ISO 08 B-1	N1/2"-10 S	15	M10	55	20	23-44	18	0.20
50	ISO 10 B-1	N5/8"-12 S	15	M12	80	35	27-65	27	0.35
60	ISO 12 B-1	N3/4"-12 S	15	M12	80	35	27-65	27	0.55
60	ISO 12 B-1	N3/4"-20 S	15	M20	100	172	38	38	0.85
80	ISO 16 B-1	N1"-20 S	13	M20	100	172	38	38	1.25
100	ISO 20 B-1	N1 1/4"-20 S	13	M20	100	172	45 / 50	45	2.00
120	ISO 24 B-1	N1 1/2"-20 S	11	M20	140	172	45 / 50	45	2.35
Duplex 'D'									
35	ISO 06 B-2	N3/8"-10 D	15	M10	55	20	27-39 / 28-39	15 / 18	2.00
40	ISO 08 B-2	N1/2"-10 D	15	M10	55	20	30-37	18	0.35
50	ISO 10 B-2	N5/8"-12 D	15	M12	80	35	36-57	27	0.60
60	ISO 12 B-2	N3/4"-12 D	15	M12	80	35	37-56	27	1.05
60	ISO 12 B-2	N3/4"-20 D	15	M20	120	172	50-90	38	1.35
80	ISO 16 B-2	N1"-20 D	13	M20	120	172	55-84	38	2.10
100	ISO 20 B-2	N1 1/4"-20 D	13	M20	140	172	60-102 / 68-102	45	3.60
120	ISO 24 B-2	N1 1/2"-20 D	11	M20	140	172	65-97 / 73-97	45	4.25
Triplex 'T'									
35	ISO 06 B-3	N3/8"-10 T	15	M10	70	20	33-48	18	0.25
40	ISO 08 B-3	N1/2"-12 T	15	M12	80	35	41-51	27	0.50
50	ISO 10 B-3	N5/8"-12 T	15	M12	80	35	43-50	27	0.95
50	ISO 10 B-3	N5/8"-20 T	15	M20	120	172	56-84	38	1.25
60	ISO 12 B-3	N3/4"-20 T	15	M20	120	172	59-80	38	1.50
80	ISO 16 B-3	N1"-20 T	13	M20	160	172	74-108	45	2.90
100	ISO 20 B-3	N1 1/4"-20 T	13	M20	160	172	78-105 / 86-105	45	5.20
120	ISO 24 B-3	N1 1/2"-20 T	11	M20	160	172	90-111 / 98-111	45	6.20

Rollerchain		Part No.	Number of Teeth	A	B	C	D	Weight (kg)
ANSI	DIN 8187							
35	ISO 06 B	N3/8"-10	15	10	5.3	9	45.81	0.06
40	ISO 08 B	N1/2"-10	15	10	7.2	9	61.08	0.15
40	ISO 08 B	N1/2"-12	15	12	7.2	12	61.08	0.15
50	ISO 10 B	N5/8"-12	15	12	9.1	12	76.36	0.27
50	ISO 10 B	N5/8"-20	15	20	9.1	15	76.36	0.29
60	ISO 12 B	N3/4"-12	15	12	11.1	12	91.63	0.47
60	ISO 12 B	N3/4"-20	15	20	11.1	15	91.63	0.47
80	ISO 16 B	N1"-20	13	20	16.1	15	106.14	0.88
100	ISO 20 B	N1 1/4"-20	13	20	18.5	15	132.67	1.60
120	ISO 24 B	N1 1/4"-20	11	20	24.1	15	135.23	1.93

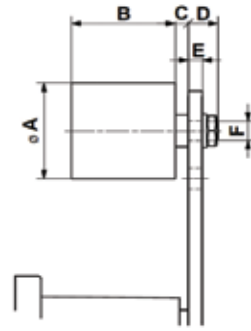

BELT DRIVE TENSIONING ROLLER

Part No.	Max. Speed (rpm)	Max. Belt width	A	B	C	D	E max.	F	Torque hex. nut (Nm)	Size SE	Weight (kg)
R 11	8000	30	30	35	2	14	5	M8	20	11	0.08
R 15/18	8000	40	40	45	6	16	7	M10	20	15/18	0.17
R 27	6000	55	60	60	8	17	8	M12	35	27	0.40
R 38	5000	85	80	90	8	25	10	M20	160	38	1.15
R 45	4500	130	90	135	10	27	12	M20	160	45	1.75



Dunlop BTL Ltd

European Distribution Centre
MPT House
Brunswick Road
Cobbs Wood Industrial Estate
Ashford, Kent. UK
TN23 1EL

Contact us

-  +44 (0)1233 663340
-  +44 (0)1233 664440
-  sales@dunlopctl.com
-  www.dunlopctl.com

Manufacturing Facilities

UNITED KINGDOM
FRANCE
GERMANY
ITALY
SPAIN
POLAND
CZECH REPUBLIC
SLOVAKIA
SERBIA
CHINA
USA



TRANSMISSIONS

DUNLOP BTL Ltd, MPT House, Brunswick Road, Cobbs Wood Industrial Estate, Ashford, Kent TN23 1EL, UK
T: +44 (0)1233 663340 • F: +44 (0)1233 664440 • E: sales@dunlopctl.com • W: www.dunlopctl.com

DUNLOP™ and the Flying D device™ are used under licence by DUNLOP BTL Ltd.